

Profili iz penaste gume



Profili iz penaste gume - vsebina

ZGODOVINSKI PREGLED	1
POSLOVNA SKUPINA SAVA	2
PROFILI IZ PENASTE GUME	3
VRVICE	4
PRAVOKOTNI PROFILI	4
CEVI	4
OBLIKA - K	5
OBLIKA - O	7
OBLIKA - T	9
OBLIKA - U	10
OBLIKA - V	14
POSEBNE OBLIKE	16

Zgodovina korporacije Sava

- 1920 - V Kranju ustanovijo družbo ATLANTA - importna in eksportna družba
- 1921 - Družba Atlanta se preimenuje v novo družbo VULKAN
- 1931 - Kranjsko podjetje postane last dunajskega podjetja SEMPERIT
- 1940 - Edini lastnik tovarne postane podjetje CONTINENTAL
- 1946 - Nacionalizacija in sprememba imena v Tovarno gumijevih izdelkov SAVA
- 1956 - Uradno odprtje Obrata II
- 1967 - Sklenitev licenčne pogodbe s Semperitom
- 1972 - Sava-Semperit, Tovarna avtopnevmatike, prične s poslovanjem
- 1985 - Continental kupi Semperit
- 1995 - Začetek pospešenih pogajanj z Goodyear Tire & Rubber Company
- 1996 - Sava postane delniška družba
- 1997 - Podpis *Joint Venture* pogodbe med korporacijo Sava in koncernom Goodyear
- 1998 - Začetek poslovanja dveh *Joint Venture* podjetij:
Goodyear Engineered Product Europe d.o.o. in Sava Tires d.o.o.
- 1998 - Sava prične z naložbeno dejavnostjo in akvizicijami (gumarski del Belinke, Golf in Kamp Bled)
- 1999 - S standardom ISO 9001 Sava certificira vse programe, pridobi prvi certifikat VDA 6.1., postane finalist priznanja za poslovno odličnost, in hiti naprej, k inženiringu poslovnih procesov.
- 2000 - Savine delnice začno kotirati na Ljubljanski borzi.
- 2000 - Sledi pospešeno uresničevanje razvojne vizije - Poslovna skupina Sava se poveča za 9 družb in postane najhitreje rastoča slovenska poslovna skupina.
- 2001 - Nadaljujejo se konsolidacija poslovne skupine, prestrukturiranje programov. Sava in njeni gumarski programi pridobijo okoljevarstveni certifikat ISO 14001.
- 2001 - Podelitev najvišjega priznanja Republike Slovenije za poslovno odličnost.
- 2002 - Dejavnost gumarskih programov se organizira v samostojno družbo Savatech, d.o.o. Sava, d.d., kot obvladujočo družbo poslovne skupine formalno preoblikujejo v holding. Delovati začne nova mešana družba Sava - Schäfer, d.o.o.
- 2003 - Uprava Save, d.d., sprejme dopolnjeno strategijo do leta 2007, njen veliki cilj je najmanj 10- odstotna donosnost. Strategija krovne družbe je podlaga strategiji družbe Savatech, d.o.o. in celotni dejavnosti Gumarstvo. Nadaljuje se prestrukturiranje proizvodnje v dejavnosti Gumarstvo; preneha poslovati družba Sava Guma, d.o.o.

Zgodovinski pregled razvoja programa Profili

- 1970 - Začetek proizvodnje gumenih profilov v Savi
- 1978 - Nabava prve LCM - linije za proizvodnjo profilov
- 1995 - Ustanovitev lastnega prodajnega podjetja v Nemčiji
- 1995 - Pridobitev certifikata BS EN ISO 9001
- 1997 - Reorganizacija programa Profili
- 1998 - Zagon nove, pete linije za proizvodnjo profilov
- 1999 - Dopolnitev programa s profili iz penaste gume
- 2000 - Pridobitev certifikata SIST ISO 14001
- 2000 - Zagon nove LCM linije
- 2004 - Zagon nove 5. LCM linije, 10 linije za proizvodnjo profilov

SAVA, d.d. - HOLDING

UPRAVA

AKTIVNO UPRAVLJANJE IN FINANČNE NALOŽBE

GUMARSTVO	KEMIJA	TRGOVINA	TURIZEM	NEPREMIČNINE	NALOŽBENE FINANCE
SAVATECH, d.o.o., Kranj	TEOL, d.d., Ljubljana - 97%	SAVA TRADE, d.d., Ljubljana - 93%	GOLF IN KAMP BLEED, d.d., Bled - 91%	SAVA IP, d.o.o., Ljubljana	REALNE NALOŽBE
SAVA ROL, d.o.o., Zagreb - 76%		MG Market Ljubljana - 74,5%	GRAND HOTEL TOPLICE, d.o.o., Bled - 95%	SAVA MEDICAL IN STORITVE, d.o.o., Kranj	NALOŽBE V INOVATIVNE PROJEKTE - Limb, d.o.o., Ptuj - 38%* - Gea Sol International, d.o.o., Kranj - 100%
SAVA-SCHÄFER, d.o.o., Kranj - 50%			GOLF IN PARK HOTELI BLEED, d.o.o., Bled - 87%		FINANČNE NALOŽBE
SAVA-GTI, d.o.o., Ptuj			TERME 3000, d.d., Moravske toplice - 95%		INSTITUCIJE
ZUNANJETRGOVINSKA MREŽA			TERME LENDAVA, d.d. Lendava - 93%		
SAVA NOVA, d.o.o., Zagreb			TERME PTUJ, d.o.o. Ptuj - 72%		
SAVA TRADE, GmbH, München			ZDRAVILIŠČE RADENCI, d.o.o., Radenci - 100%		
SAVA TRADE, Sp.z.o.o., Warszawa					
SAVA TRADE, s.r.o., Praha					
SAVATECH TRADE, Ltd, London					
SAVA TRADE, Inc, Port Orange - 95%					

DEJAVNOSTI

■ Družbe v 100-odstotni lasti Save, d.d.

■ Družbe v večinski lasti Save, d.d.

* Pridobitev večinskega deleža v družbi Limb, d.o.o. načrtujemo v letu 2005

Profili iz penaste gume

Profili iz penaste gume nas rešijo skrbi glede tesnjenja, dušenja vibracij in izolacije pred mrazom oziroma vročino.

Razvili smo etilensko-propilenske in kloroprenske gumene zmesi, iz katerih izdelujemo proizvode, ki bodo zadovoljili še tako zahtevnega projektanta.

V februarju 1998 je *Bureau Veritas Quality International* certificiral razvoj, proizvodnjo in prodajo gumenih profilov po standardu kakovosti BS EN ISO 9001, v decembru 2000 pa smo pridobili tudi certifikat ISO 9001, leta 2001 smo pridobili tudi okoljevarstveni certifikat ISO 14001, leta 2004 pa mednarodni standard na področju varnosti in zdravja pri delu OHSAS 18001.

Profili iz penaste gume so izdelki iz porozne gume z mešano celično strukturo, gladko zaprto površino in nizko specifično težo. Njihova stisljivost, mehkoča, prožnost in prilagodljivost neravnim površinam omogočajo skoraj idealno tesnjenje. Odporni so proti vremenskim vplivom, proti ozonu in staranju, proti vročini in mrazu in proti najrazličnejšim mineralnim oljem. So upogljivi in visoko elastični, imajo pa še veliko drugih ugodnih kemičnih in fizikalnih lastnosti.

Nekatere izdelujemo tudi v samolepilni izvedbi.

V nadaljevanju so profili iz penaste gume razporejeni po obliki in namenu uporabe v posamezne skupine.

IZBIRA MATERIALA

Pri izbiri kakovosti gume je treba upoštevati posebne zahteve po fizikalnih in kemičnih lastnostih pa tudi temperaturno območje uporabe.

Material	Posebne lastnosti	Temperaturno območje uporabe (°C)		
		od	do	kratkotrajno
Etilen propilen (EPDM)	Odpornost proti vremenskim vplivom, ozonu, staranju, vročemu zraku	- 35	110	150
Kloropren (CR)	Samougasljivost, odpornost proti staranju, vremenskim vplivom, vročemu zraku, ozonu, slani vodi; delna odpornost proti mineralnim oljem	- 35	110	130



TRDOTA

Trdota profilov iz penaste gume se meri z merilcem trdote po skali Shore A in je od 15 do 25 ShA. Toleranca trdote je normalno $\pm 5^0$ Sh.

BARVA

EPDM profile iz penaste gume izdelujemo v črni, sivi, rjavi, beli in rdeči barvi.

CR profile iz penaste gume izdelujemo samo v črni barvi.

TOLERANCE DIMENZIJ

Tolerance dimenzij za profile iz penaste gume so v mejah, ki jih dovoljuje standard ISO 3302-1 razreda E3. V posameznih primerih dosegamo tudi tolerance dimenzij v mejah razreda E2.

Dimenzija (mm)	Toleranca (\pm mm) Razred E3	Toleranca (\pm mm) Razred E2
1.5 - 2.5	0.50	0.35
2.5 - 4	0.70	0.40
4.0 - 6.3	0.80	0.50
6.3 - 10	1.00	0.70
10 - 16	1.30	0.80
16 - 25	1.60	1.00
25 - 40	2.00	1.30
40 - 63	2.50	1.60
63 - 100	3.20	2.00

Dimenzija (mm)		Razred L1 \pm (mm)	Razred L2 \pm (mm)	Razred L3 \pm (mm)
od	do			
0	40	0.7	1.0	1.6
40	63	0.8	1.3	2.0
63	100	1.0	1.6	2.5
100	160	1.3	2.0	3.2
160	250	1.6	2.5	4.0
250	400	2.0	3.2	5.0
400	630	2.5	4.0	6.3
630	1000	3.2	5.0	10.0
1000	1600	4.0	6.3	12.5
1600	2500	5.0	10.0	16.0
2500	4000	6.3	12.5	20.0
4000		0.16 %	0.32 %	0.50 %

Za rezanje na dolžino velja standard ISO 3302-1, razred L3.

NAROČANJE PROFILOV

Profile naročate tako, da navedete:

- načrt profila s karakterističnimi merami,
- skico mesta in načina vgradnje,
- kemične in fizikalne vplive na profil,
- potrebno količino,
- dolžino,
- način pakiranja.

Če naročate profil po vzorcu, ga izdelamo po dimenzijah vzorca. Ob naslednjih naročilih zadostuje, da navedete naziv profila. Ker izdelujemo veliko različic profilov, vam v tem katalogu nismo mogli pokazati vseh. Če imate posebne želje, če želite profile drugačnih dimenzij, oblik, ožjih toleranc itd., kot smo jih pokazali v katalogu, nas pokličite ali nam pišite. Prav gotovo bomo ustregli vašim zahtevam.

OBLIKA PROFILOV

Profili so razdeljeni glede na obliko in namen uporabe v posamezne skupine:

VRVICE

PRAVOKOTNI PROFILI

CEVI

OBLIKA - K

OBLIKA - O

OBLIKA - T

OBLIKA - U

OBLIKA - V

POSEBNA OBLIKA

VRVICE

Vrvice izdelujemo v dimenzijah premera 2 do 60 mm v črni barvi in premera 2 do 20 mm v kakršnikoli drugi barvi.

PRAVOKOTNI PROFILI

Označevanje: a x b (mm)

Pravokotne profile izdelujemo v naslednjih dimenzijah:

od 2 x 5 mm do 50 x 50 mm v črni barvi - EPDM

od 2 x 5 mm do 20 x 40 mm v črni barvi - CR

od 2 x 5 mm do 15 x 20 mm v katerikoli drugi barvi - EPDM

CEVI

Označevanje: zunanji / notranji premer (mm)

Dimenzije: max. 48/min. 3

Kvalitete: EPDM,CR

Barve: EPDM črna, siva in barvni odtenki
CR črna

Dimenzije (mm)		
Ø 9 / 3	Ø 18 / 10	Ø 28 / 12
Ø 10 / 6	Ø 20 / 9.5	Ø 30 / 9
Ø 12 / 5	Ø 20 / 10	Ø 30 / 10
Ø 13 / 5	Ø 20 / 12	Ø 30 / 12
Ø 13 / 8	Ø 20 / 12.5	Ø 30 / 16
Ø 13.5 / 4	Ø 22 / 7	Ø 30 / 19
Ø 13.5 / 5	Ø 22 / 8	Ø 32 / 10
Ø 13.5 / 9.5	Ø 22 / 10	Ø 32 / 12
Ø 14 / 7	Ø 24 / 12	Ø 34 / 22
Ø 14 / 8	Ø 24 / 14	Ø 35 / 15
Ø 14 / 10	Ø 25 / 10	Ø 35 / 18
Ø 15 / 9	Ø 25 / 15	Ø 36 / 18
Ø 17 / 9	Ø 25 / 16	Ø 36 / 22.5
Ø 18 / 8	Ø 25 / 19	Ø 36 / 24
Ø 18 / 8.5	Ø 26 / 12	Ø 46 / 20
Ø 18 / 9	Ø 26 / 16	Ø 48 / 22
Ø 18 / 8.5	Ø 26 / 18	
Ø 18 / 9	Ø 28 / 9	

03 013 E

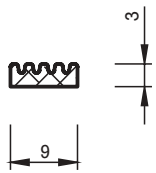

1:1

03 009 E

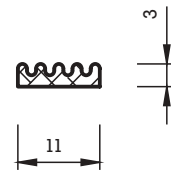

1:1

03 010 E

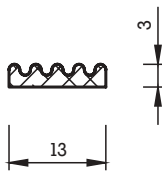

1:1

03 011 E

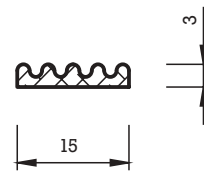

1:1

03 020 E

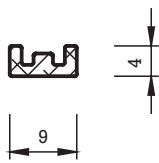

1:1

03 038 E

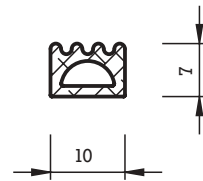

1:1

03 042 E

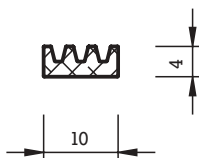

1:1

03 060 E

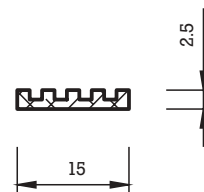

1:1

03 085 E

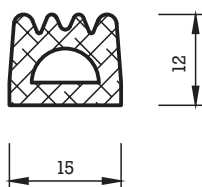

1:1

03 092 E

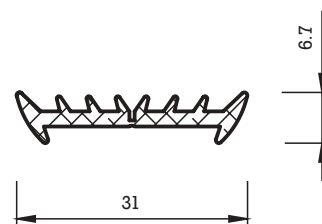

1:1

03 116 E

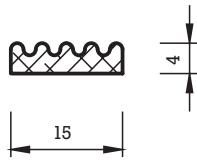

1:1

03 123 E

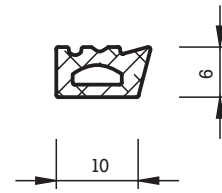

1:1

03 136 E

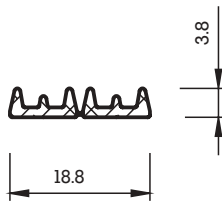

1:1

03 138 E

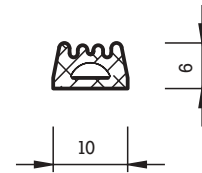

1:1

03 139 E

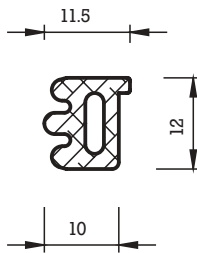

1:1

03 140 E

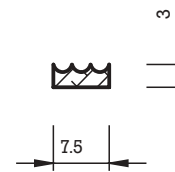

1:1

03 142 E

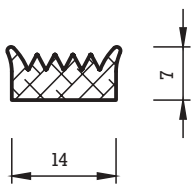

1:1

03 110 E

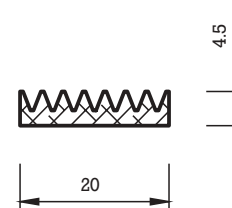

1:1

03 144 E

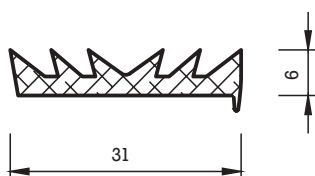

1:1

03 145 E

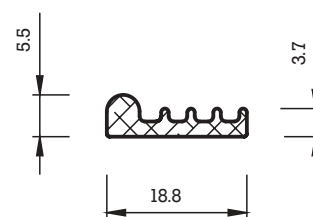

1:1

04 001 E

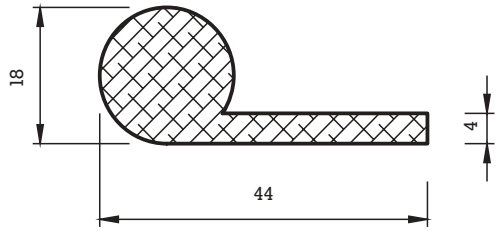

1:1

04 008 E

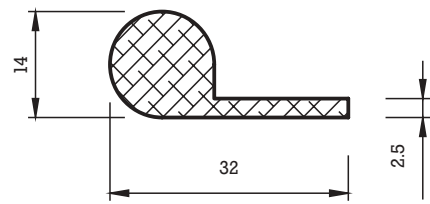

1:1

04 002 E

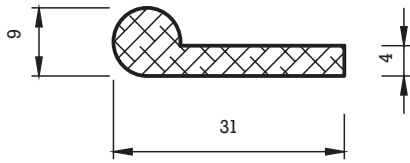

1:1

04 003 E

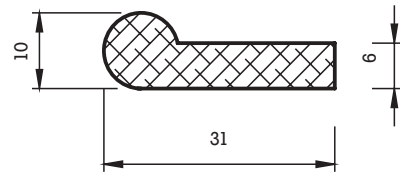

1:1

04 012 E

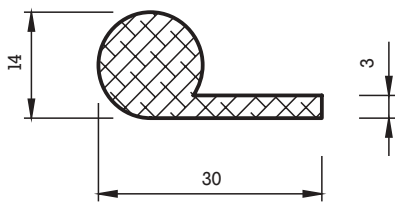

1:1

04 004 E

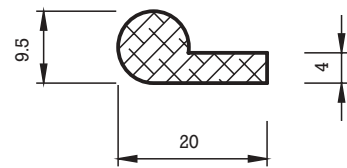

1:1

04 010 E

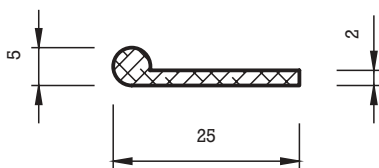

1:1

04 013 E

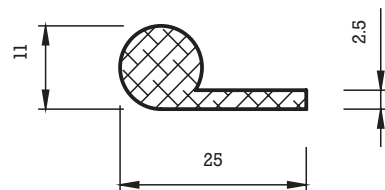

1:1

04 025 E

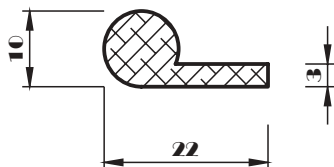

1:1

04 051 E

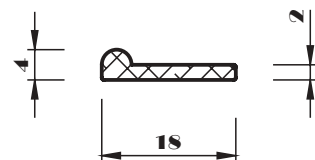

1:1

04 057 E

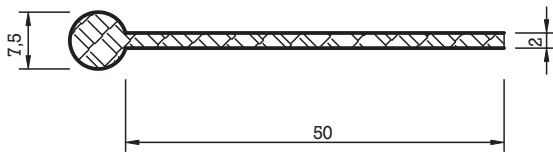

1:1

04 020 E

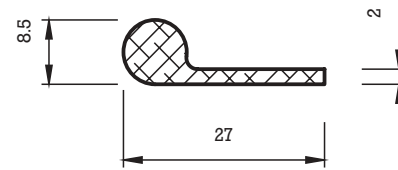

1:1

04 058 E

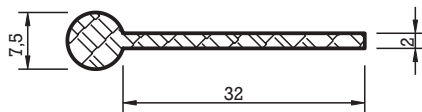

1:1

04 046 E

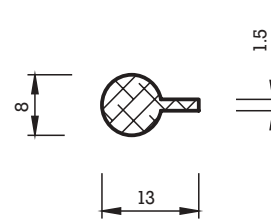

1:1

04 025 E

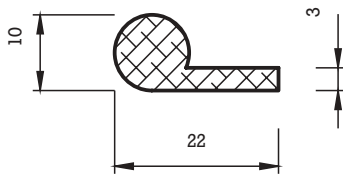

1:1

04 036 E

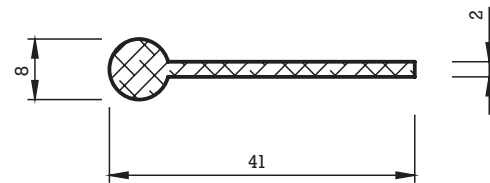

1:1

04 031 E

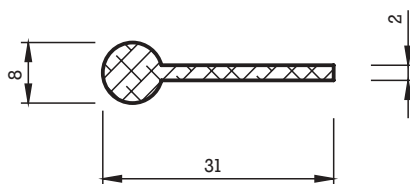

1:1

04 038 E

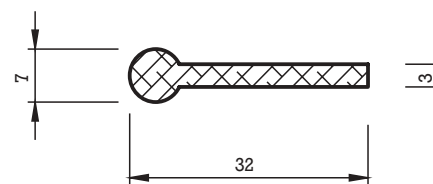

1:1

04 040 E

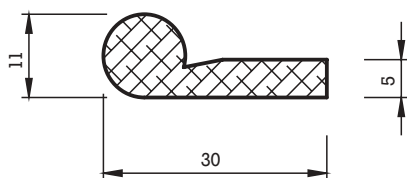

1:1

04 019 E

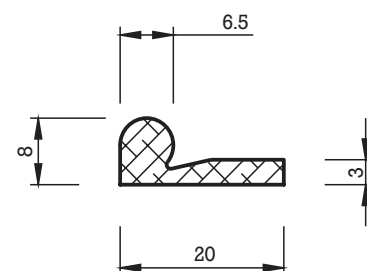

1:1

05 001 D

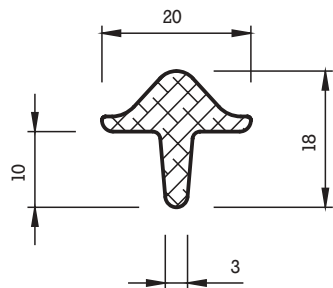

1:1

05 002 E

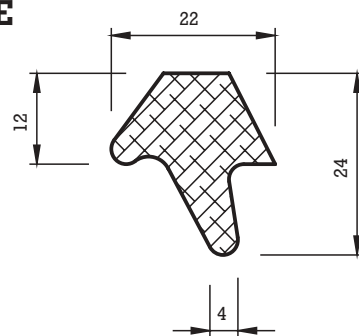

1:1

05 005 D

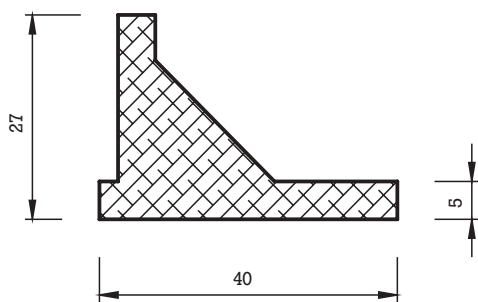

1:1

05 014 E

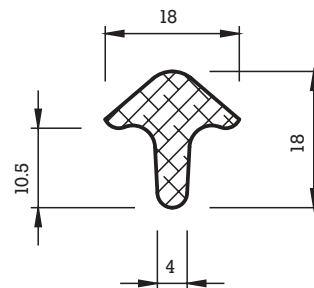

1:1

05 013 E

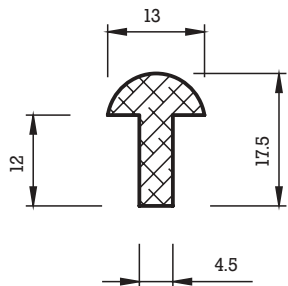

1:1

05 037 E

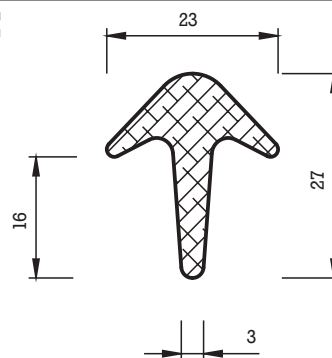

1:1

05 031 E

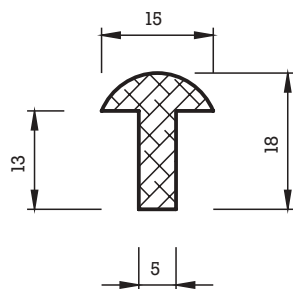

1:1

05 018 E

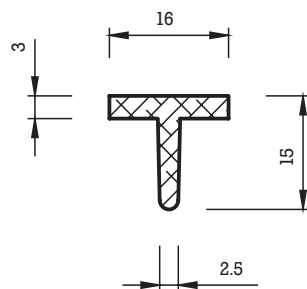

1:1

05 038 E

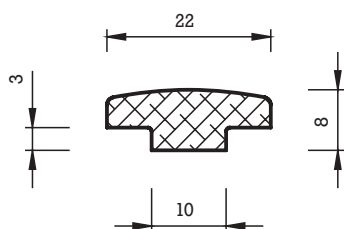

1:1

05 025 E

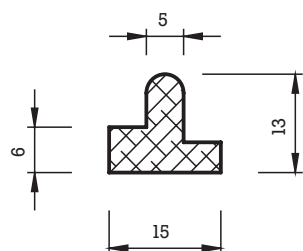

1:1

06 002 D

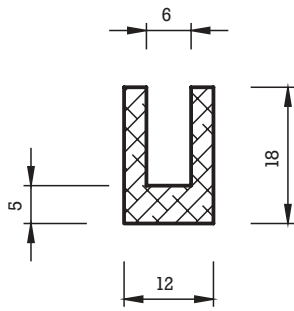

1:1

06 003 E

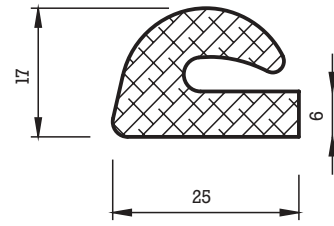

1:1

06 005 D

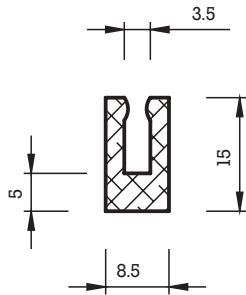

1:1

06 026 E

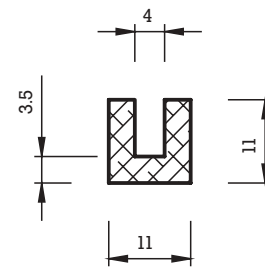

1:1

06 019 E

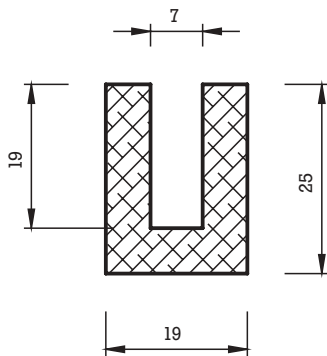

1:1

06 024 E

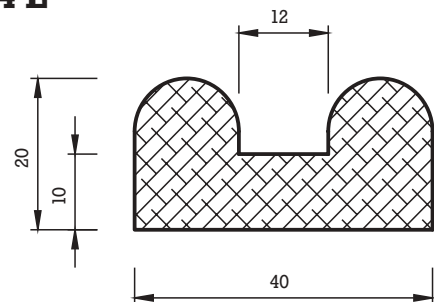

1:1

06 021 E

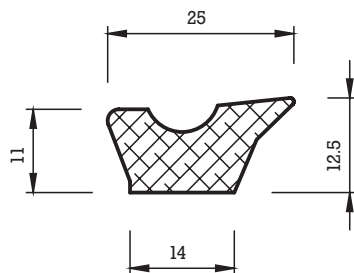

1:1

06 001 D

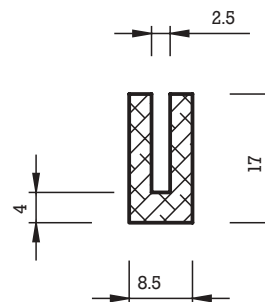

1:1

06 016 E

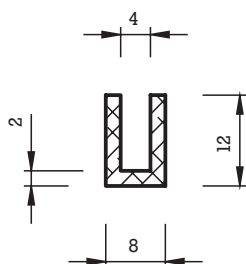

1:1

06 015 E

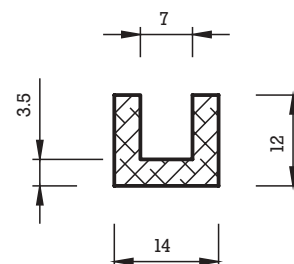

1:1

06 031 D

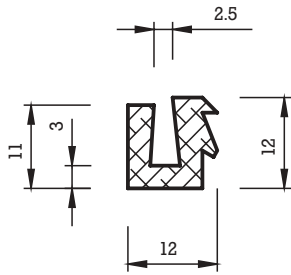

1:1

06 033 E

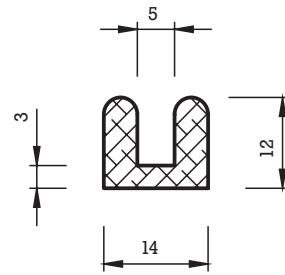

1:1

06 042 E

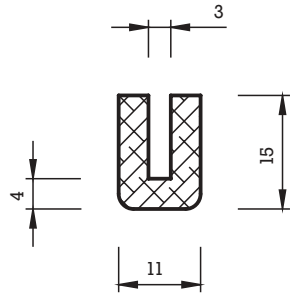

1:1

06 038 E

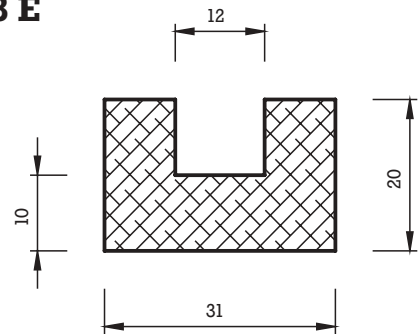

1:1

06 041 E

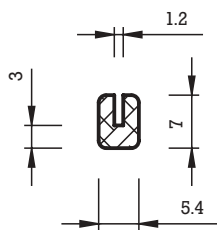

1:1

06 046 E

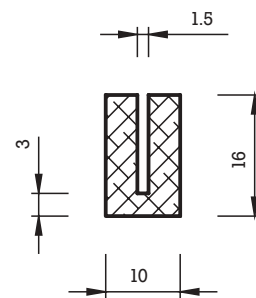

1:1

06 050 E

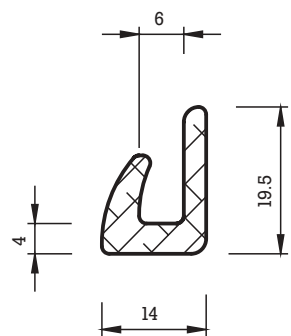

1:1

06 063 E

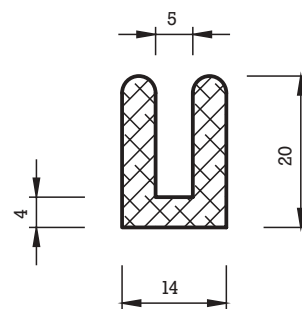

1:1

06 069 E

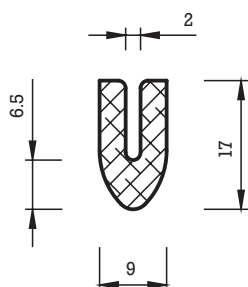

1:1

06 018 E

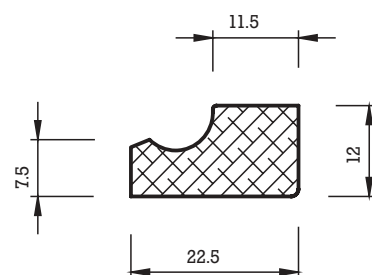

1:1

06 089 E

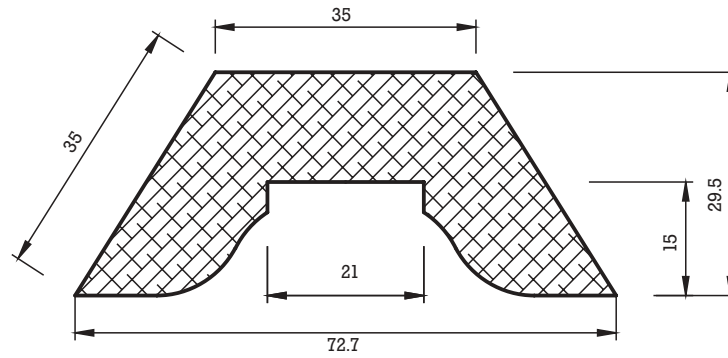

1:1

06 062 E

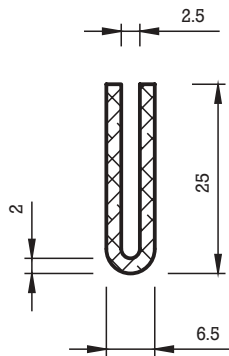

1:1

06 088 E

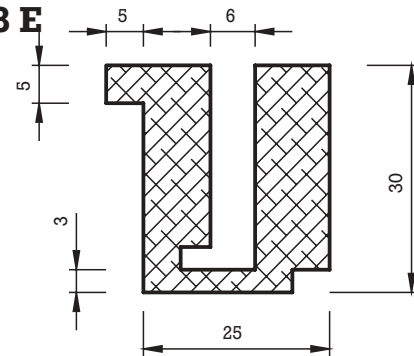

1:1

06 086 E

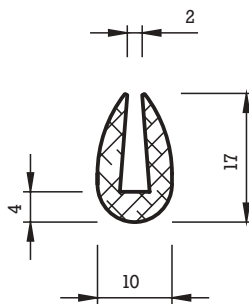

1:1

06 095 E

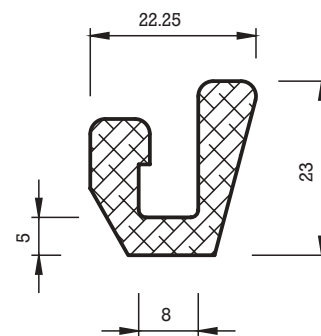

1:1

06 094 E

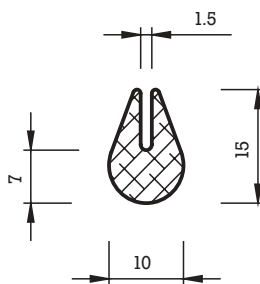

1:1

06 102 E

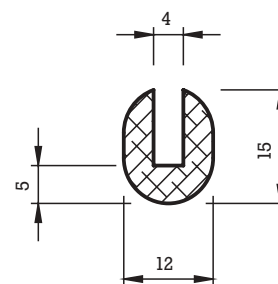

1:1

06 108 E

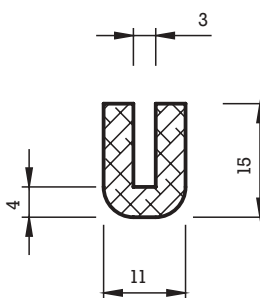

1:1

06 111 E

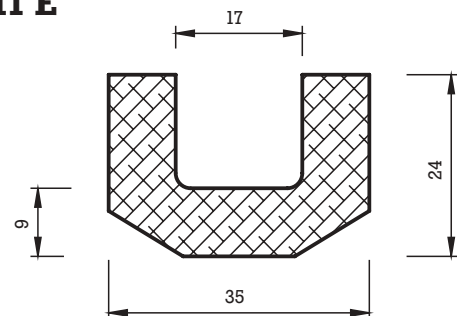

1:1

06 114 E

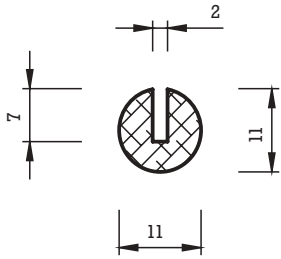

1:1

06 113 E

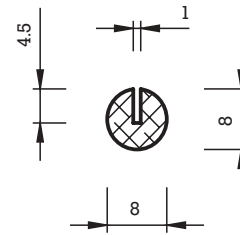

1:1

06 115 E

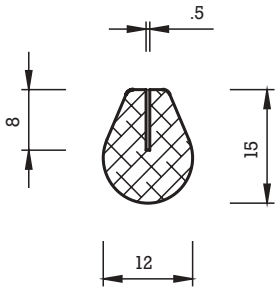

1:1

06 114 E

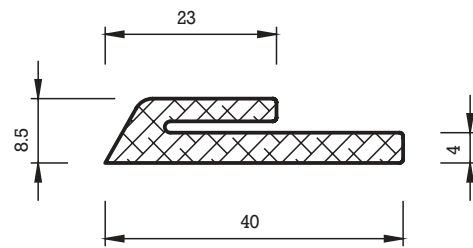

1:1

06 120 E

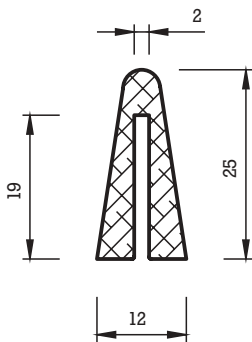

1:1

06 118 E

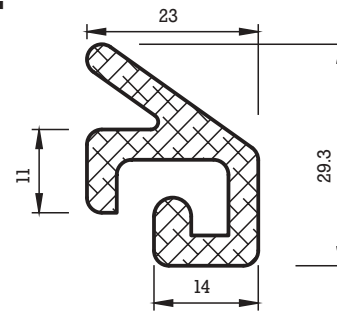

1:1

06 123 E

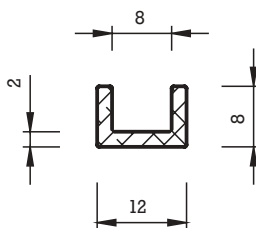

1:1

06 124 E

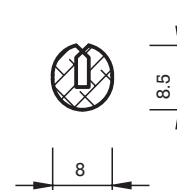

1:1

07 001 D

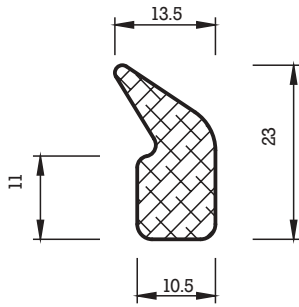

1:1

07 006 D

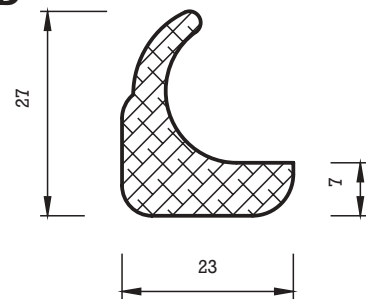

1:1

07 023 E

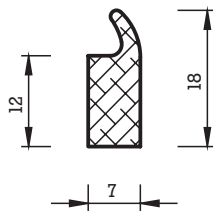

1:1

07 002 E

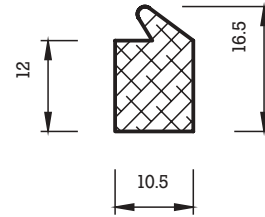

1:1

07 010 E

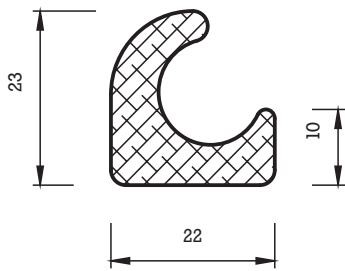

1:1

07 026 E

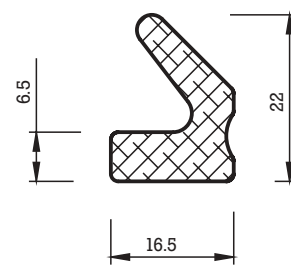

1:1

07 021 E

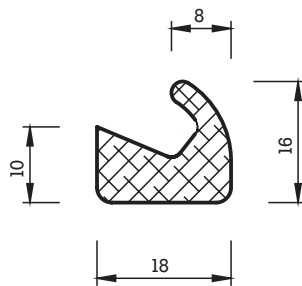

1:1

07 018 E

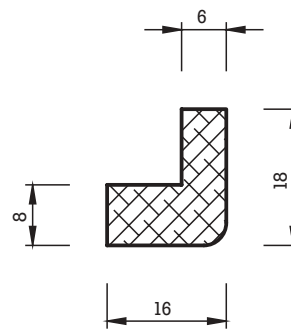

1:1

07 022 E

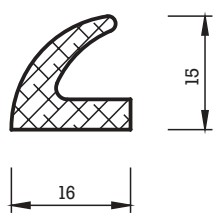

1:1

07 042 E

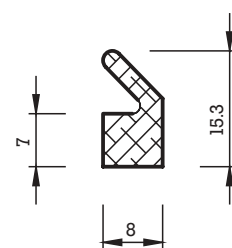

1:1

07 047 E

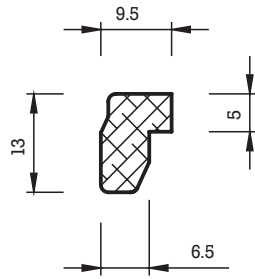

1:1

07 054 E

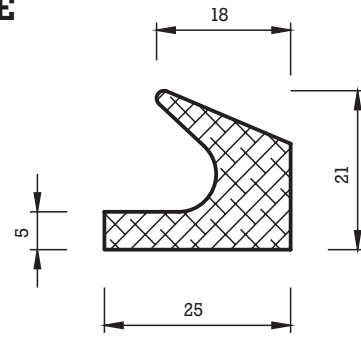

1:1

07 044 D

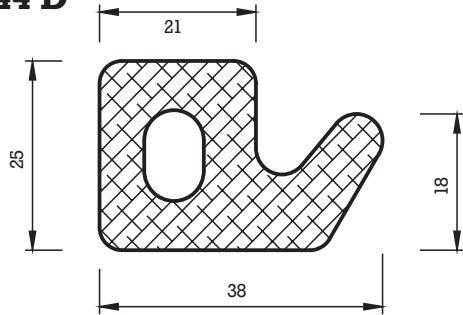

1:1

07 071 E

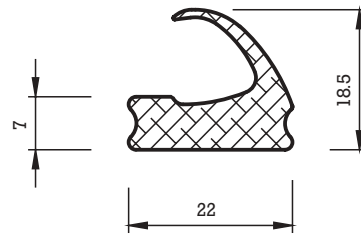

1:1

07 065 E

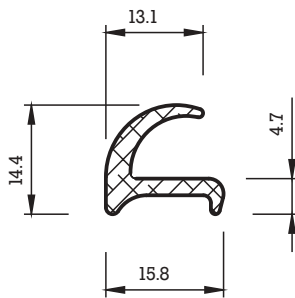

1:1

07 067 E

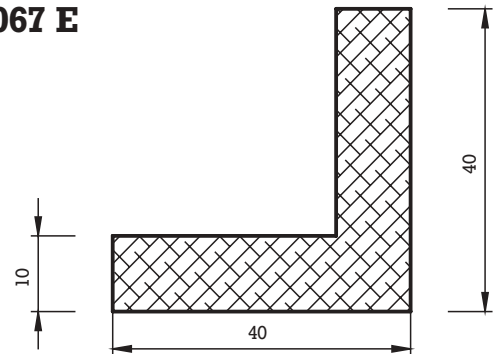

1:1

07 073 E

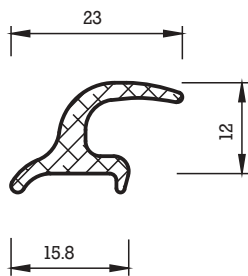

1:1

07 069 E

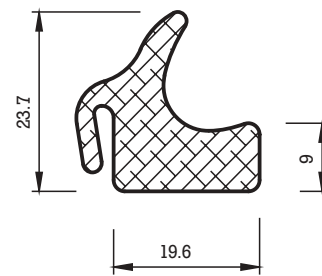

1:1

07 062 E

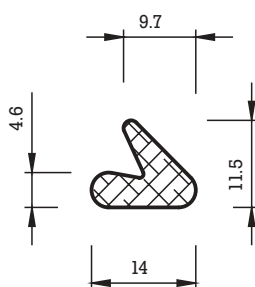

1:1

07 050 E

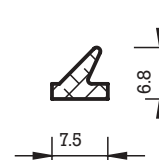

1:1

Posebne oblike

09 086 E

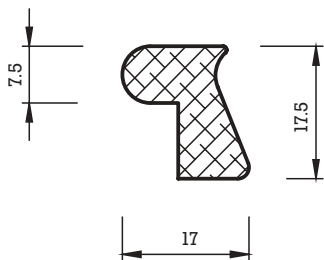

1:1

09 090 E

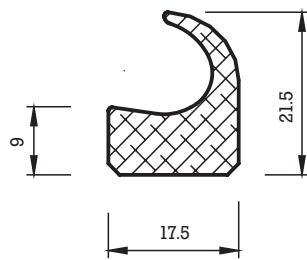

1:1

09 091 E

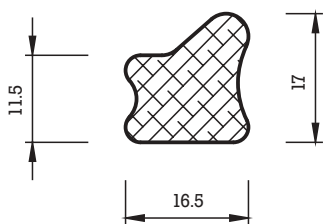

1:1

09 112 E

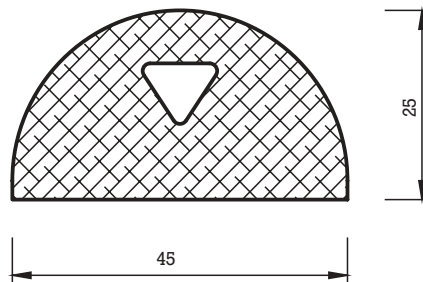

1:1

09 140 E

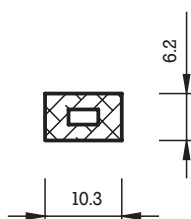

1:1

09 123 E

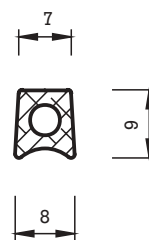

1:1

09 018 E

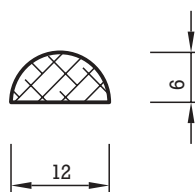

1:1

09 128 E

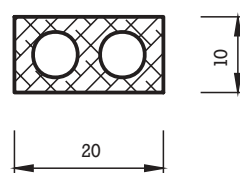

1:1

09 131 E

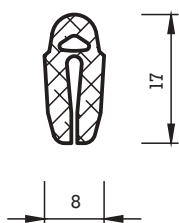

1:1

09 139 E

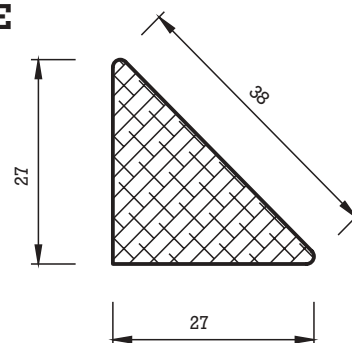

1:1

09 012 C

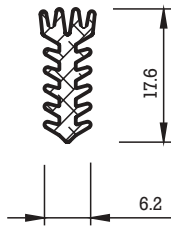

1:1

09 017 D

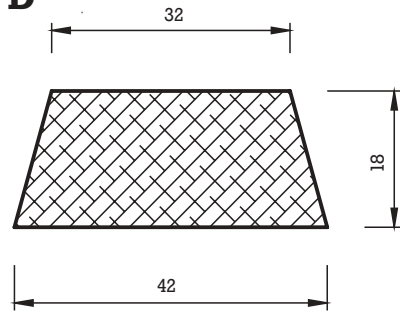

1:1

09 129 E

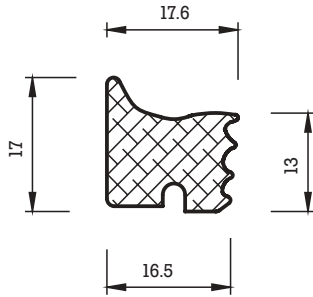

1:1

09 049 E

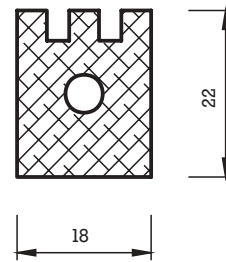

1:1

09 022 E

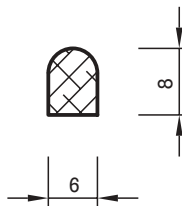

1:1

09 187 E

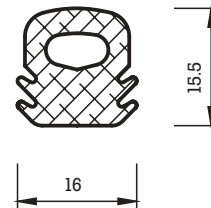

1:1

09 191 E

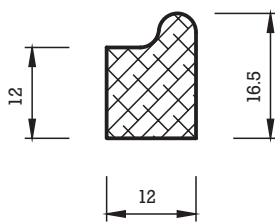

1:1

09 209 E

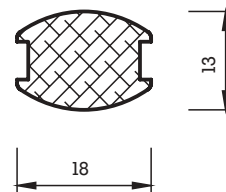

1:1

09 223 E

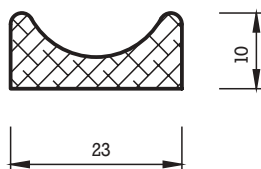

1:1

09 216 E

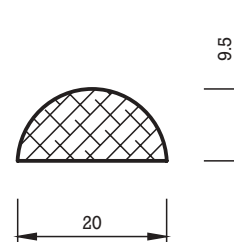

1:1

Posebne oblike

09 234 E

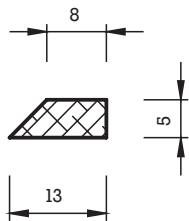

1:1

09 173 E

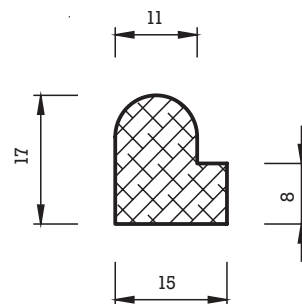

1:1

09 237 E

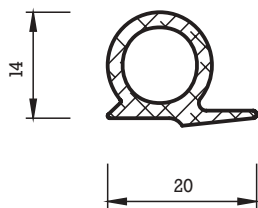

1:1

09 236 E

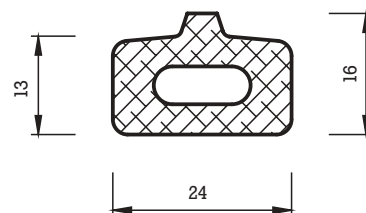

1:1

09 227 E

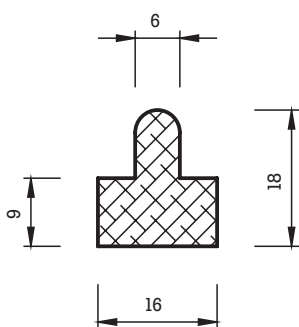

1:1

09 247 E

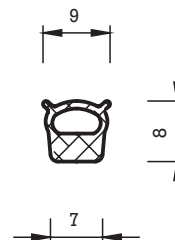

1:1

09 261 E

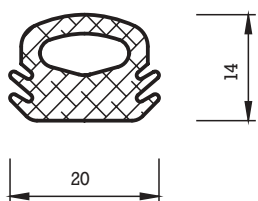

1:1

09 262 E

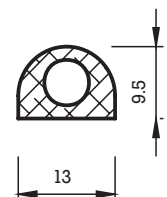

1:1

09 281 E

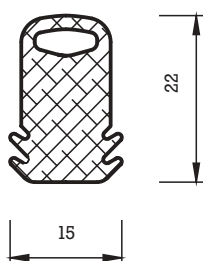

1:1

09 282 E

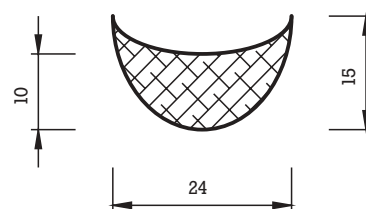

1:1

09 279 E

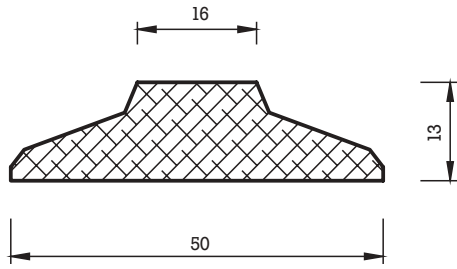

1:1

09 300 E

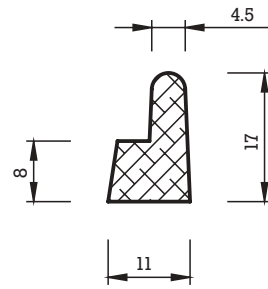

1:1

09 331 E

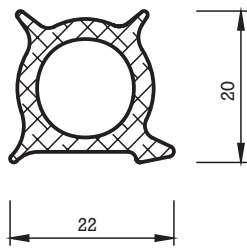

1:1

09 332 E

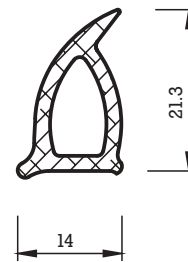

1:1

09 303 E

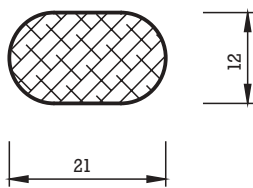

1:1

09 323 E

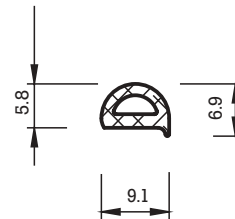

1:1

09 322 E

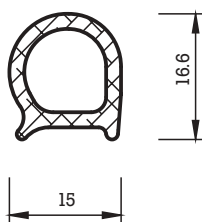

1:1

09 324 E

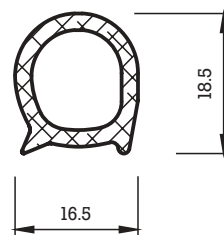

1:1

09 267 E

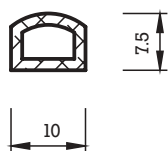

1:1

09 330 E

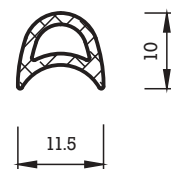

1:1

Posebne oblike

09 333 E

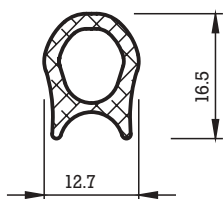

1:1

09 336 E

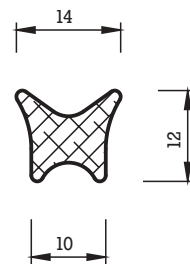

1:1

09 337 E

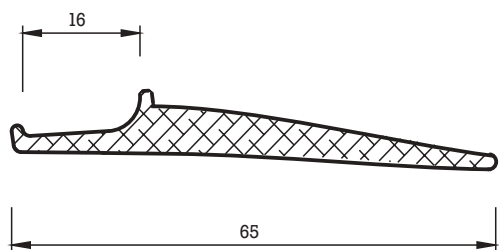

1:1

09 172 E

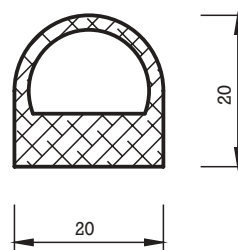

1:1

09 343 E

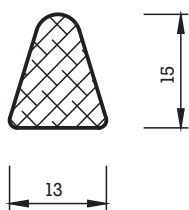

1:1

09 362 E

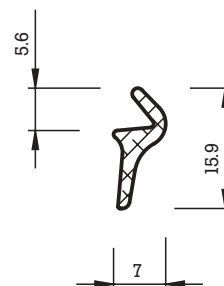

1:1

09 350 E

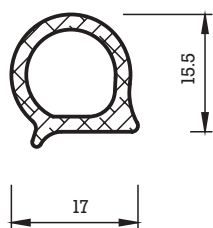

1:1

09 026 D

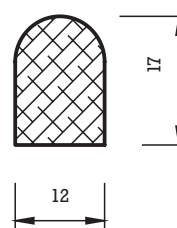

1:1

09 352 E

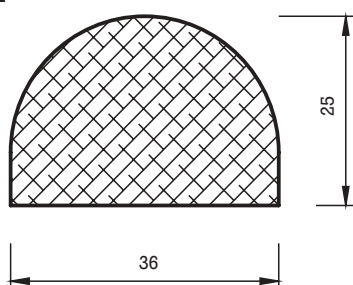

1:1

09 355 E

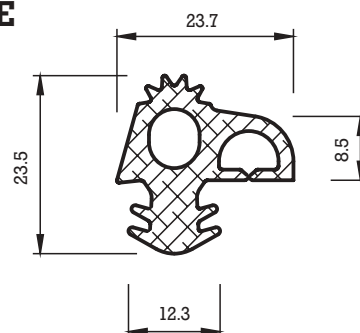

1:1

09 366 E

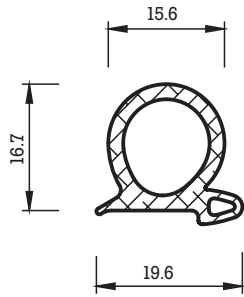

1:1

09 373 E

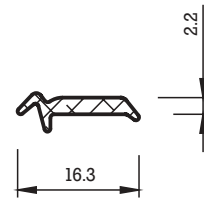

1:1

09 376 E

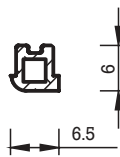

1:1

09 387 E

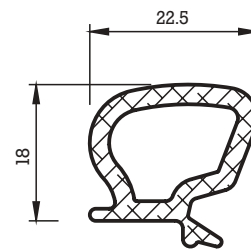

1:1

09 389 E

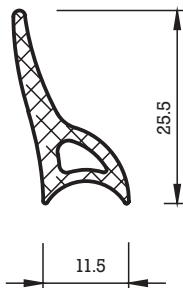

1:1

09 393 E

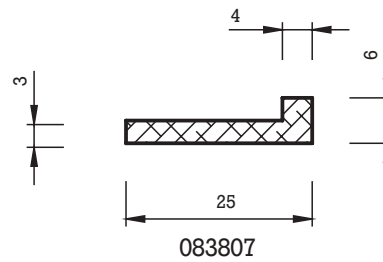

1:1

09 394 E

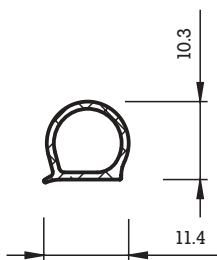

1:1

09 397 E

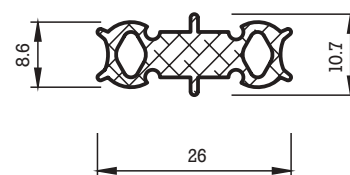

1:1

09 398 E

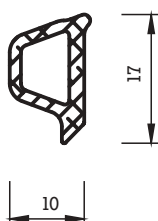

1:1

09 404 E

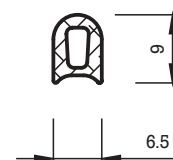

1:1

Posebne oblike

09 437 E

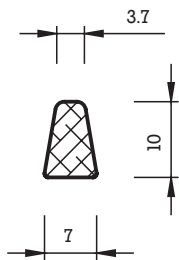

1:1

09 423 E

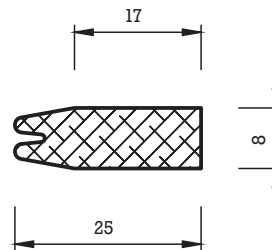

1:1

09 425 E

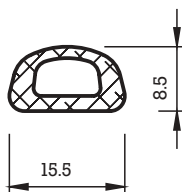

1:1

09 426 E

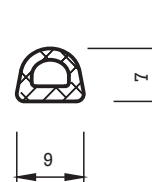

1:1

09 429 E

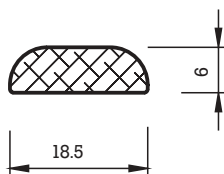

1:1

09 430 E

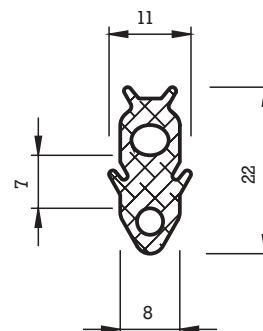

1:1

09 432 E

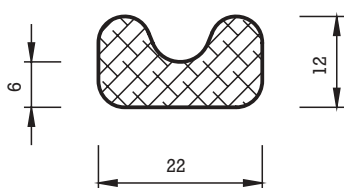

1:1

09 157 E

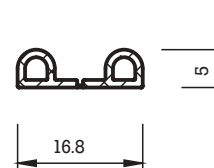

1:1

09 434 E

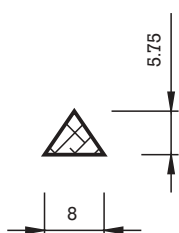

1:1

09 435 E

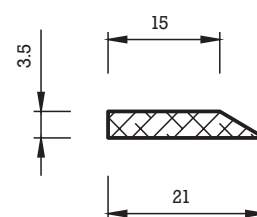

1:1

09 218 E

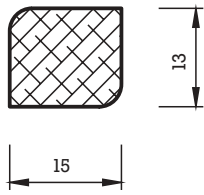

1:1

09 440 E

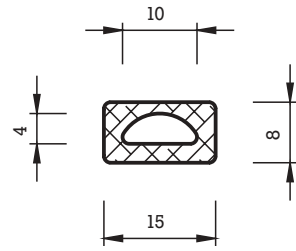

1:1

09 441 E

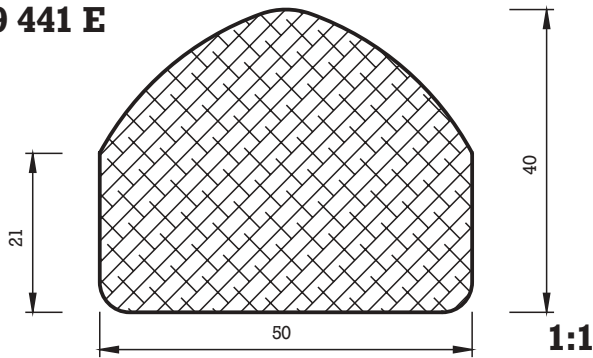

1:1

09 442 E

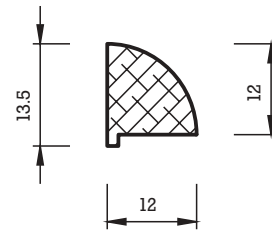

1:1

09 444 E

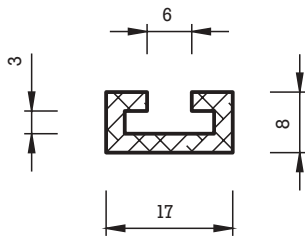

1:1

09 445 E

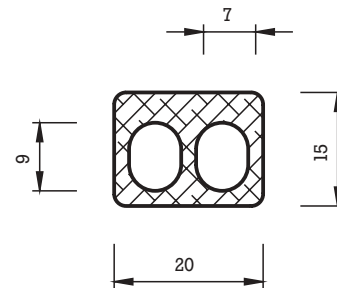

1:1

09 448 E

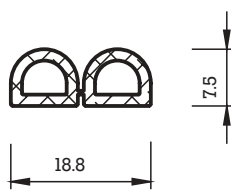

1:1

09 447 E

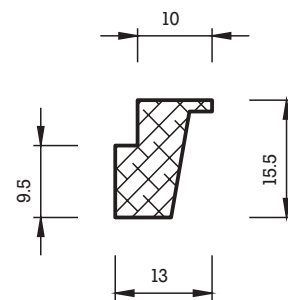

1:1

SAVA TRADE, Vertriebsgesellschaft, G.m.b.H., München

Zlatko Smrdel
Kobellstrasse 2a, 80336 München
Tel.: +49 89 544 14 30
Fax: +49 89 532 89 51
E-mail: zlatko.smrdel@sava-trade.de

SAVA TRADE, Vertriebsbüro Nürnberg

Maik Sohr
Pilotystrasse 5, 90408 Nürnberg
Tel.: +49 911 93 59 480
Fax: +49 911 93 59 4848
E-mail: maik.sohr@sava-trade.de

SAVA TRADE, s.r.o., Praha

Roman Drapela
Sokolska 66, 12000 Praha 2
Tel.: +420 22 494 19 66
Fax: +420 22 49 42 559
E-mail: roman.drapela@savatrade.cz

SAVA TRADE, Sp. z o.o., Warszawa

Matjaž Suln
Ul.Przyparkowa 19, 05-850 Ozarów Mazowiecki, Jawczyce
Tel.: +48 22 721 13 62
Fax: +48 22 721 13 61
E-mail: matjaz.suln@savatrade.com.pl

SAVATECH TRADE Ltd., London

Boatjan Podjed
Airport House, Purley Way, Croydon, Surrey CRD DXZ
Tel.: + 44 020 82 88 35 08
Fax: +44 020 86 88 00 55
E-mail: boatjan.podjed@savatech.f9.co.uk

SAVA TRADE Inc., Port Orange

Tony Imunac
413 Oak Place, Building 5 J-O, Port Orange, FL 32127
Tel.: +1 386 760 07 06
Fax: +1 386 760 87 54
E-mail: savatrade@bellsouth.net

Predstavništvo SAVATECH v Moskvi

Branimir Andeli
D. Ulyanova 16/2, Apt. 413, 117292 Moscow
Tel.: +7 095 775 38 46
Fax: +7 095 775 38 47
E-mail: branimir.andjelic@savatech.ru

Predstavništvo SAVATECH v Trstu

Niko Golemac
Col 54, 34016 Repentabor
Tel.: +39 347 155 34 86
Fax: +39 348 859 14 00
E-mail: nikogolemac@hotmail.com

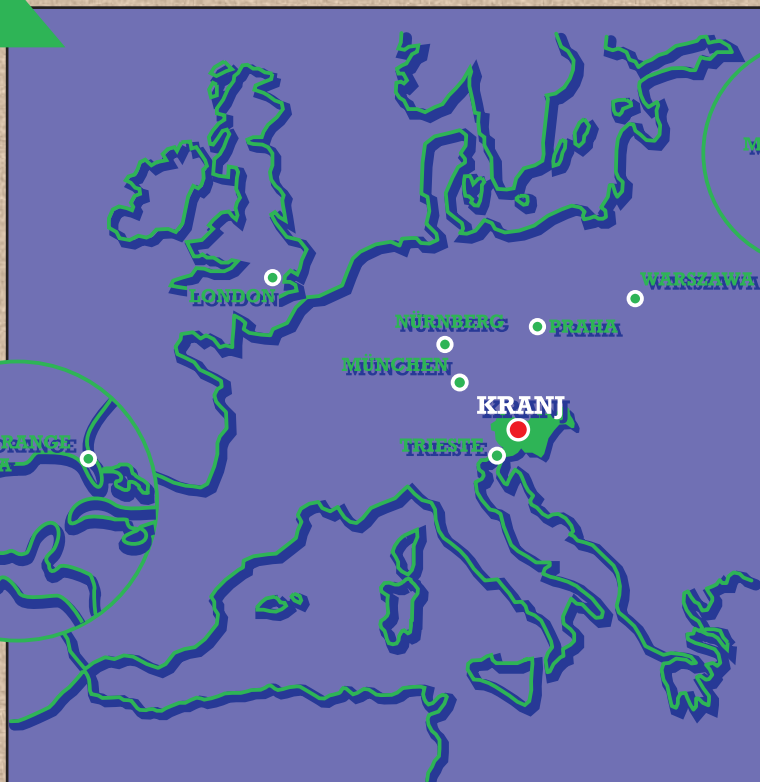

Sava 

Savatech, d.o.o.
Proizvodnja in trženje gumeno-
tehničnih proizvodov in pnevmatike

Program Profili

Škofjeloška c.6, 4502 Kranj, Slovenija
tel.: + 386 4 206 64 71
fax: + 386 4 206 54 75
<http://www.sava.si/savatech>

Distributer:

Zaradi nadaljnega razvoja si pridružujemo pravico do spremembe navedenih podatkov in karakteristik. Ta prospekt je zgolj orientacijske narave; za podrobnejše informacije se obrnite na naše strokovnjake.